

# Manual G509A

## 1KVA-5KVA (PF=1) Inverter/charger



Version: 1.1

# Safety instructions



**WARNING: This chapter contains important safety and operating instructions. Read and keep this manual for future reference.**

1. Read all instructions and warning labels on the unit, batteries, and all applicable sections of this manual before using the equipment.
2. **WARNING-**To reduce the risk of injury, charge only deep cycle lead acid batteries. Other types of batteries can rupture and cause personal injury and damage.
3. Do not disassemble the device. If service or repair is required, take it to a qualified service center. Improper reassembly may result in a risk of electric shock or fire.
4. To reduce the risk of electric shock, disconnect all lines before any maintenance or cleaning. Turning off the equipment will not reduce this risk.
5. **WARNING -** Only qualified personnel should install this device with the battery.
6. **NEVER** charge a frozen battery.
7. For optimum operation of this inverter/charger, follow the required specifications and select the appropriate cable size. It is very important to operate this inverter/charger correctly.
8. Be very careful when working with or around battery-powered metal tools. There is a potential risk of dropping the tool due to sparking or short circuiting batteries or other electrical components and may cause an explosion.
9. If you want to disconnect the AC or DC terminals, follow the installation procedure carefully. Refer to the **INSTALLATION** section of this manual for details.
10. One piece of 150 A fuse is provided as overcurrent protection for the battery power supply.
11. **GROUNDING INSTRUCTIONS -**This inverter/charger should be connected to a permanently grounded wiring system. Observe local requirements and codes when installing this inverter.
12. **NEVER** short circuit the AC output and DC input. **DO NOT** connect to the mains when the DC input is shorted.
13. **Warning!!** Only qualified service personnel may service this equipment. If errors persist after performing the troubleshooting chart, please return this inverter/charger to your local dealer or service center for maintenance.

# Home

It is a multifunctional inverter/charger that combines the functions of an inverter, solar charger and battery charger and offers uninterrupted power support. The advantage is the easy to access button control.

There are two different types of embedded solar controllers: the PWM solar controller and the MPPT solar controller. Please contact your local dealer for detailed product specification.

## Functions

- Pure sine wave inverter
- Configurable input voltage range for home appliances and personal computers via LCD settings
- Configurable battery charging current
- Configurable AC/solar charger priority via LCD settings
- Compatible with mains voltage or generator power
- Automatic restart while AC is restoring
- Overload/overtemperature/short circuit protection
- Smart charger features for optimised battery performance
- Cold start function

## Basic system architecture

The following picture shows the basic use of this inverter/charger. It also includes the following devices that have a complete running system:

PV modules

Generator or source

This inverter can power all kinds of appliances in home or office environment, including motorized appliances such as tube light, fan, refrigerator and air conditioner

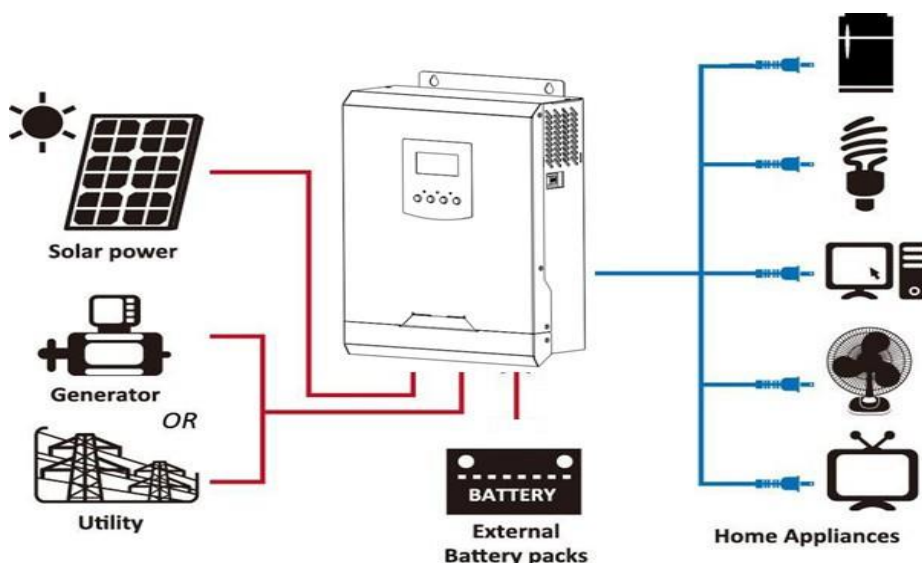
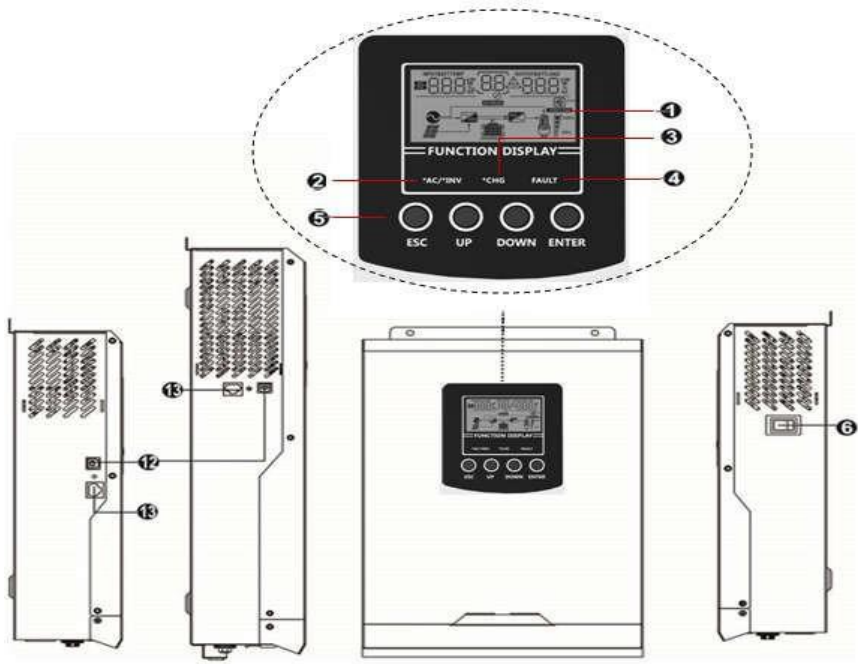

Figure 1 Hybrid system

Solar power - solar panels, Generator or utility - generator or common source, External battery packs - external batteries, home appliances - home appliances.

# Product description



1KVA/2KVA  
Side view

3KVA / 5KVA  
Side view

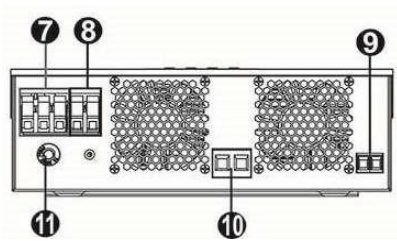

5KVA model

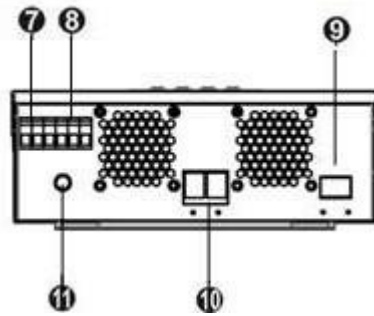

1KVA/2KVA with PWM model

1. LCD display
2. Status indicator
3. Charging indicator
4. Error indicator
5. Function buttons
6. On/Off button
7. AC input
8. AC output
9. PV input
10. Battery input
11. Circuit switch
12. USB communication port
13. RS-232 communication port

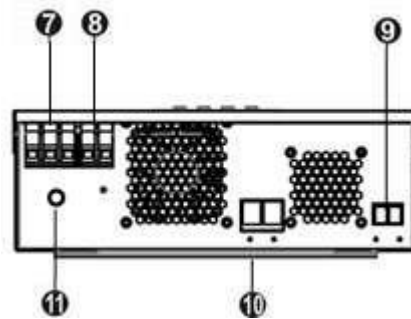

3KVA model

# INSTALLATION

## Unpacking and first check

Please check the unit before installation. Make sure that nothing inside the package is damaged. You should have received the following items in the package:

Unit x 1 User manual x

1 Communication cable

x 1

## Preparation

Before connecting all cables, remove the bottom cover by removing the two screws as shown below.

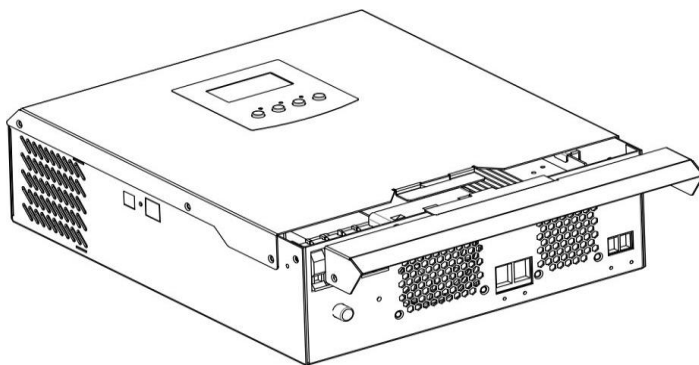

## Installation of the unit

Consider the following points before selecting an installation site: do not install the inverter on combustible building materials.

Mount it on a solid surface

Install this inverter at eye level to read the LCD display.

For proper air circulation for heat dissipation, leave a free space of approx. 20 cm to the side and approx. 50 cm above and below the unit.

For optimum operation, the ambient temperature should be between 0°C and 55°C.

The recommended mounting position is vertically to the wall.

Make sure that there is sufficient heat dissipation and sufficient space for wire removal.

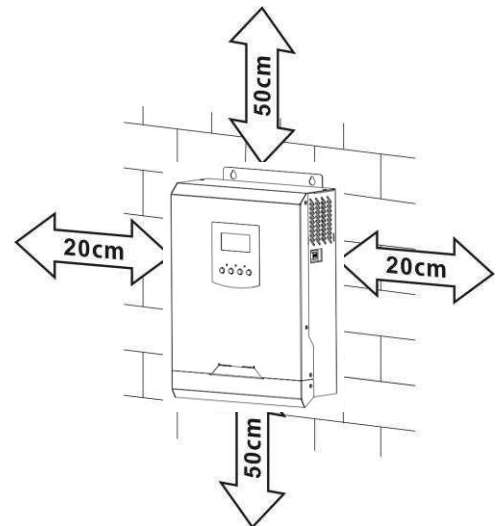

**SUITABLE FOR MOUNTING ONLY ON CONCRETE OR OTHER NON-PUBLIC SURFACES.**

Install the unit by screwing in the two screws. It is recommended to use M4 or M5 screws.

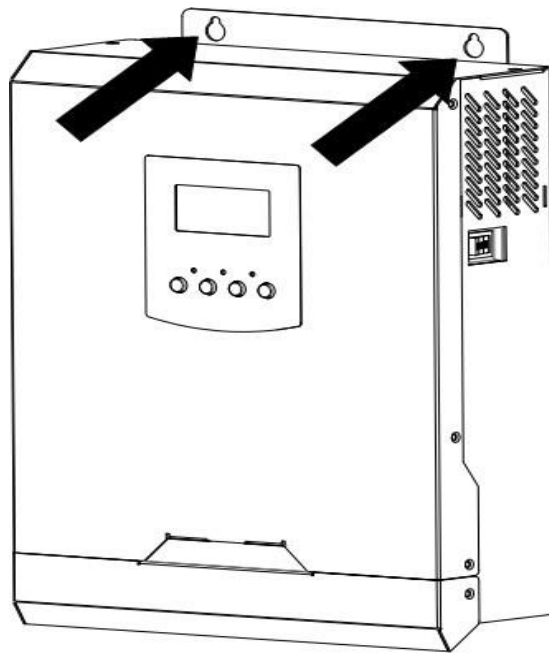

## Battery connection

**CAUTION:** To ensure safe operation and regulatory compliance, a separate DC overcurrent protector must be installed or the equipment must be disconnected between the battery and the inverter. Refer to the table below for the required fuse or circuit breaker size.

**WARNING!** All wiring must be done by qualified personnel.

**WARNING!** For system safety and efficient operation, it is very important to use a suitable battery connection cable. To reduce the risk of injury, use the correct recommended cable as shown below.

### Recommended cable size

Model	Vein	Cable <sup>2</sup> (mm)	Torque value (max)
1KVA/ 2KVA	1 x 4AWG	25	2 Nm
3KVA/ 5KVA	1 x 2AWG	35	

Follow the instructions below to connect the battery:

1. For positive and negative conductors, remove the insulating sleeve (18 mm).
2. It is recommended to fit the sleeves to the end of the positive and negative wires using a suitable crimping tool.
3. Attach the strain relief plate to the inverter with the supplied screws as shown below.

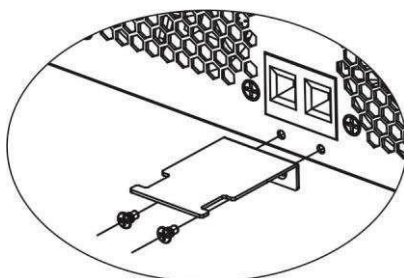
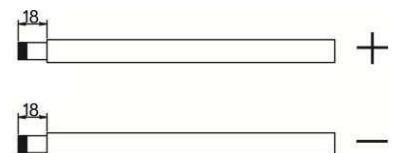

4. The 1KVA model supports 12VDC system, the 2KVA/3KVA model supports 24VDC system and the 5KVA model supports 48VDC system. Connect all batteries according to the following table. It is recommended to connect at least 100Ah battery for 1-3KVA model and at least 200Ah battery for 5KVA model.

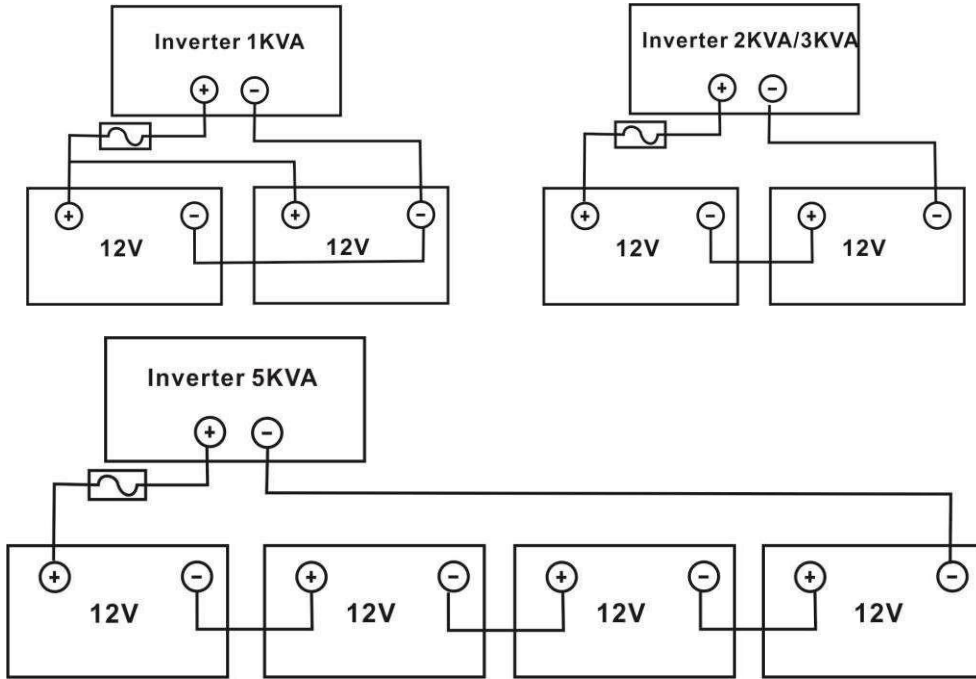

5. Insert the battery wires flat into the battery connectors of the inverter and make sure that the screws are tightened to 2 Nm clockwise. Ensure that the battery and inverter/charging polarity are correctly connected and the wires are screwed firmly to the battery terminals.

Recommended tool: #2 Pozi screwdriver

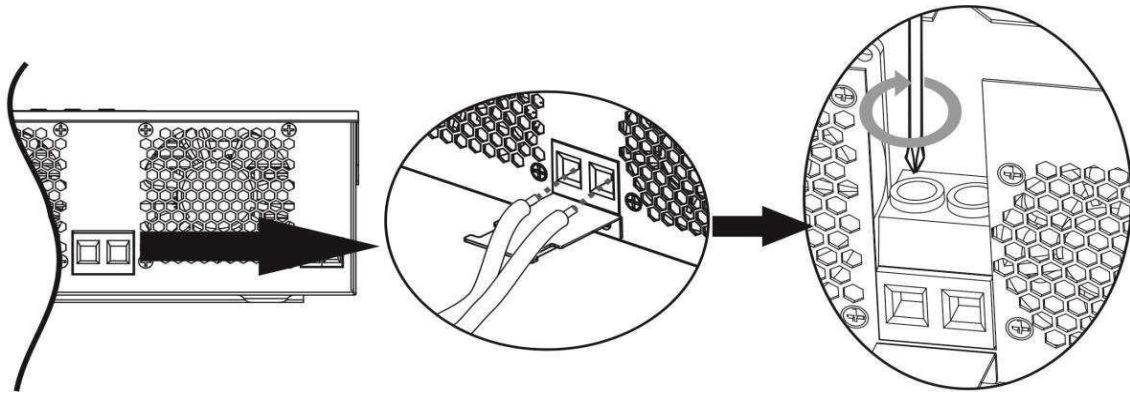

6. If you want to secure the wire connections firmly, you can secure the wires with a strain relief tape.

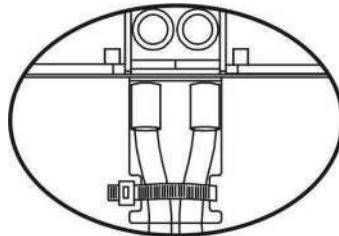

**ATTENTION!!** Before making the final DC connection or disconnecting the DC circuit breaker/disconnect, make sure that the positive wire (+) must be connected to the positive (+) and the negative (-) must be connected to the negative.

**WARNING: Risk of injury! Installation must be careful due to the high voltage of the batteries in series.**

## AC input/output connection

**ATTENTION!!** Please install a separate disconnecter between the inverter and the AC power source before connecting to the AC power source. This will ensure that the inverter can be safely disconnected during maintenance and fully protected from AC input overcurrent. The recommended specification of the AC circuit breaker is 10A for 1KVA, 20A for 2KVA, 32A for 3KVA and 50A for 5KVA.

**ATTENTION!!** There are two terminals marked "IN" and "OUT". Caution incorrect connection of input and output connectors.

**WARNING!** All wiring must be done by qualified personnel.

**WARNING!** For system safety and efficient operation, it is very important to use a suitable cable to connect the AC input. To reduce the risk of injury, use the correct recommended cable size as shown below.

Table of recommended cables

Model	Vein	Cable (mm <sup>2</sup> )	Torque value
1KVA	16 AWG	1.5	0.6 Nm
2KVA	14 AWG	2.5	1.0 Nm
3KVA	12 AWG	4	1.2 Nm
5KVA	10 AWG	6	1.2 Nm

When implementing an AC input/output connection, proceed as follows::

1. Before connecting the AC input/output, first open the DC protector or disconnecter.
2. Remove the 10 mm insulating sleeve for the six wires. And shorten the L phase and N neutral wire 3 mm.
3. For 1KVA/2KVA models, simply connect the AC power supply to the AC input of the inverter with a plug. For 3KVA-5KVA models, insert the AC input wires according to the polarity indicated on the terminal block and tighten the terminal screws. Be sure to connect the PE protective conductor first (⊕).

⊕ → **Ground - Earth (yellow-green)**

**L** → **LINE - wire (brown or black)**

**N** → **Neutral - zero wire (blue)**

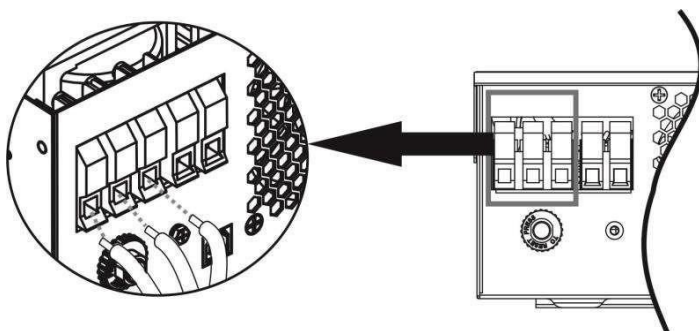

### Warning:

Make sure the AC power is disconnected before attempting to connect it firmly to the unit.

4. Then connect the AC output wires according to the polarity marked on the terminal block and tighten the terminal screws. Do not forget to connect the PE protective conductor first (⊕).

⊕ → **Earth (yellow/green)**

**L** → **Line (brown/black)**

**N** → **Neutral (blue)**



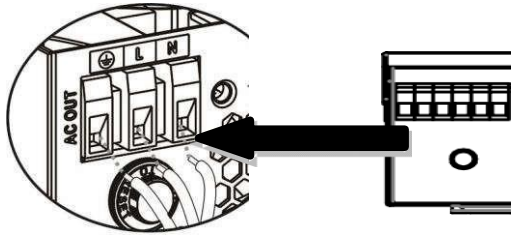

**1KVA/2KVA**

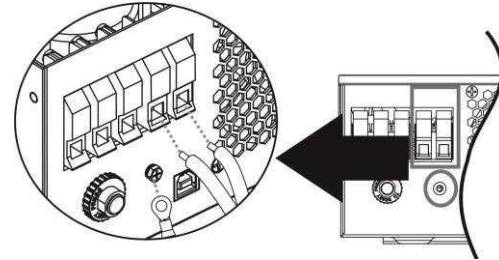

**3KVA/5KVA**

5. Check that the wires are securely connected.

**CAUTION:** Appliances such as air conditioners require at least 2 to 3 minutes to restart, as it is necessary to have enough time to balance the refrigerant gas inside the circuits. If power is lost and restored within a short time, it will cause damage to the connected appliances. To avoid this type of damage, please check with the air conditioner manufacturer before installation if it is equipped with a time delay feature. Otherwise, this inverter/charger will cause an overload fault and turn off the output to protect your appliance, but sometimes it can still cause internal damage to the air conditioner.

## PV connection

WARNING: It is prohibited for an inverter to share the same group of solar panels.

NOTE: Before connecting to PV modules, install a separate DC circuit breaker between the inverter and PV modules. WARNING! For system safety and efficient operation, it is very important to use a suitable cable for PV module connection. To reduce the risk of injury, use the correct recommended cable size as shown below.

Model	Vein	Cable (mm <sup>2</sup> )	Torque value (max)
1KVA/2KVA/3KVA	1 x 8AWG	10	1.6 Nm
3KVA Plus/5KVA			

### PV module selection: (Only for model with PWM solar charger)

When selecting the right PV modules, first consider the following requirements::

- Open circuit Voltage (Voc) of PV modules does not exceed max. The open circuit voltage of the PV generator.

Charging current (PWM)	50A mp		
System DC voltage	12Vdc	24Vdc	48Vdc
Operating voltage range	15~18V dc	30~32V dc	60~72v dc
Max. Open circuit voltage of PV array	55Vdc	80Vdc	105Vdc

- Max. The supply voltage (Vmp) of PV modules should be close to the highest Vmp of the inverter or be in the Vmp range to achieve the best performance. If one PV module cannot meet this requirement, it is necessary to have several PV modules in series.

Maximum number of PV modules in series: Vmp of PV module \* X pcs = Highest Vmp of inverter or

Vmp range Number of PV modules in parallel: Max inverter charging current / Imp

Total number of PV modules = maximum number of PV modules in series \* Number of PV modules in parallel

To select the right PV modules, take a 1KVA inverter as an example. After considering the Voc of the PV module will not exceed 50 Vdc. A max. Vmp of PV module is close to 15Vdc or is in the range of 13Vdc~18Vdc. We can choose the PV module with the specification below.

Maximum power (Pmax)	85W	PV modules in series 1 → 17.6 x 1 ≈ 15 ~ 18
Max. Voltage Vmp (V)	17.6V	
Max. Power current Imp (A)	4.83A	PV modules in parallel 10 → 50 A / 4.83. Total number of PV modules 1 x 10 = 10
Open circuit voltage Voc (V)	21.6V	
Short circuit current Isc (A)	5.03A	

**Maximum number of PV modules in series: 1 , number of PV modules in parallel: 10 Total number of PV modules: 1 x 10 = 10**

Use the 2KVA/3KVA model as an example to select the right PV module. After considering the Voc of the PV module, do not exceed 80 Vdc and max. Vmp of PV module is close to 30Vdc or is within 30Vdc~32Vdc, we can choose PV module with below specification.

Maximum power (Pmax)	260W	Max. PV module numbers in series 1 → 30.9 x 1 ≈ 30 ~ 32
Max. Voltage Vmp (V)	30.9V	
Max. Power current Imp (A)	8.42A	PV module numbers in parallel 6 → 50 A / 8.42 Total PV module numbers 1 x 6 = 6
Open circuit voltage Voc (V)	37.7V	
Short circuit current Isc (A)	8.89A	

**Maximum number of PV modules in series: 1  
Number of PV modules in parallel: 6, Total number of PV modules: 1 x 6 = 6**

To select the right PV module, take the 5KVA inverter as an example. After considering the Voc of the PV module, do not exceed 105 Vdc and max. Vmpp of PV module is 60Vdc or the range of 56Vdc ~ 72Vdc. We can choose PV module with the specification below

Maximum power (Pmax)	260W	Max. Number of PV modules in series 2 → 30.9 x 2 ≅ 56 ~ 72
Max. Voltage Vmpp (V)	30.9V	
Max. Power current Impp (A)	8.42A	Number of PV modules in parallel 6 → 50 A / 8.42 Total number of photovoltaic modules 2 x 6 = 12
Open circuit voltage Voc (V)	37.7V	
Short circuit current Isc (A)	8.89A	

**Maximum number of PV modules in series: 2**  
**Number of PV modules in parallel: 6**  
**Total number of PV modules: 2 x 6 = 12**

**PV module selection: (Only for model with MPPT solar charger)**

When choosing the right PV modules, remember to take into account the parameters listed below:

1. open circuit voltage (Voc) of PV modules does not exceed max. The open circuit voltage of the PV inverter.
2. The open circuit voltage (Voc) of PV modules should be higher than the minimum battery voltage.

Inverter model	1KVA	2KVA	3KVA	5KVA
Max. Open circuit voltage of PV array	102V dc			
Voltage range of MPPT PV inverter	15~80V dc	30~80Vdc		60~115V dc

Take the 250Wp PV module as an example. After considering the above two parameters, the recommended module configurations for 3KVA, 3KVA Plus and 5KVA are shown in the following table.

Maximum power (Pmax)	250W	1 KVA: 2 pieces in series. 2KVA/3KVA: 2 pieces in series and 2 sets in parallel. 3KVA Plus: 2 pieces in series and 3 sets in parallel, or 3 pieces in series and 2 sets in parallel. 5 KVA: 2 pieces in series and 6 sets in parallel, or 3 pieces in series and 4 sets in parallel
Max. Voltage Vmpp (V)	30.1V	
Max. Power current Impp (A)	8.3A	
Open circuit voltage Voc (V)	37.7V	
Short circuit current Isc (A)	8.4A	

When connecting the PV module, proceed as follows:

**Photovoltaic module connection**

1. For positive and negative connectors, remove the insulating sleeve (10 mm).
2. It is recommended to fit the sleeves to the end of the positive and negative wires using a suitable crimping tool.
3. Attach the strain relief plate to the inverter with the supplied bolts as shown in the following table.

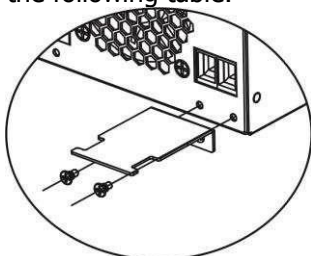
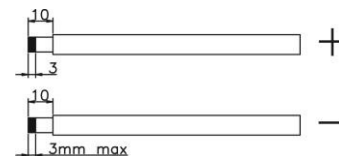

4. Check the correct polarity of the wires from the PV modules and the PV input connectors. Then connect the positive pole (+) of the connection wire to the positive pole (+) of the PV input connector. Connect the negative pole (-) of the connection wire to the negative pole (-) of the PV input connector. Screw the two wires tightly in a clockwise direction. Recommended tool: 4mm screwdriver

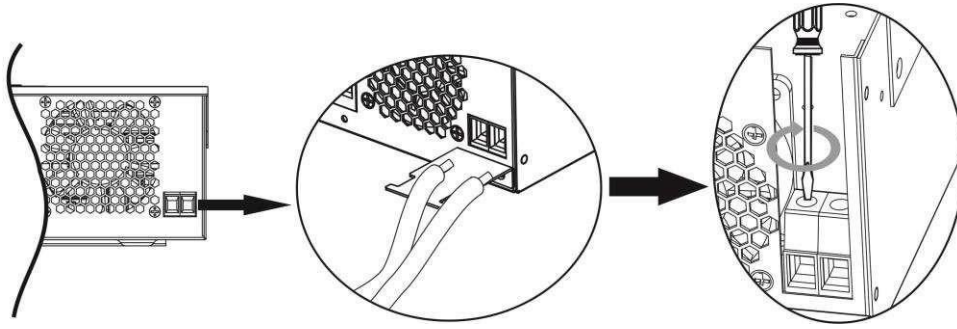

5. To ensure a secure connection of the wires, secure the wires to the strain relief with strain relief tape.

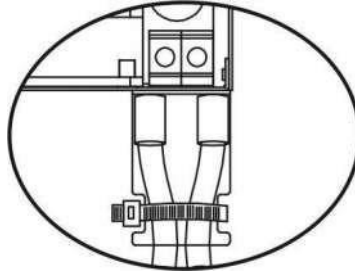

## Final steps

After all cables are connected, replace the bottom cover by screwing back the two screws as shown below.

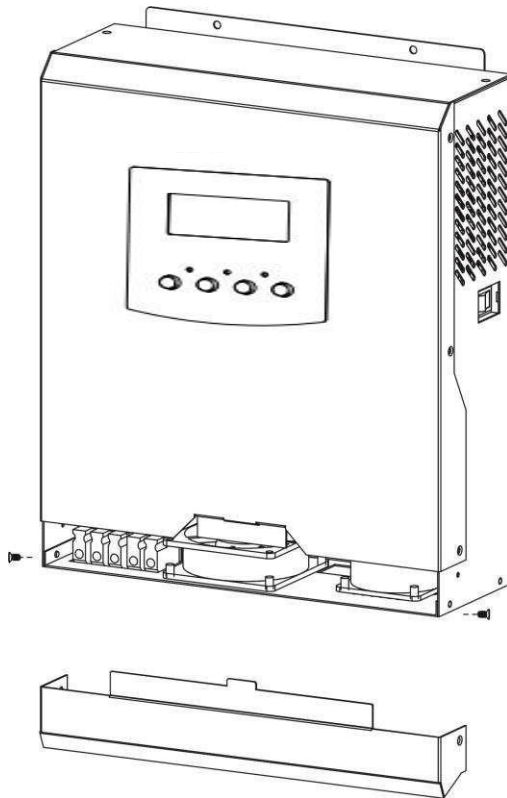

## Connecting a communication interface

Use the supplied communication cable to connect the inverter to the computer.

# Use

## Switching on / off

View of the unit

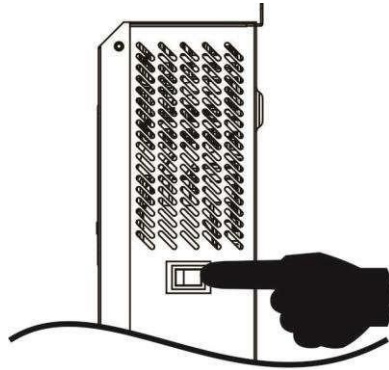



Once the unit is properly installed and the batteries are properly connected, simply turn the unit on by pressing the power switch.

## Control and display panel

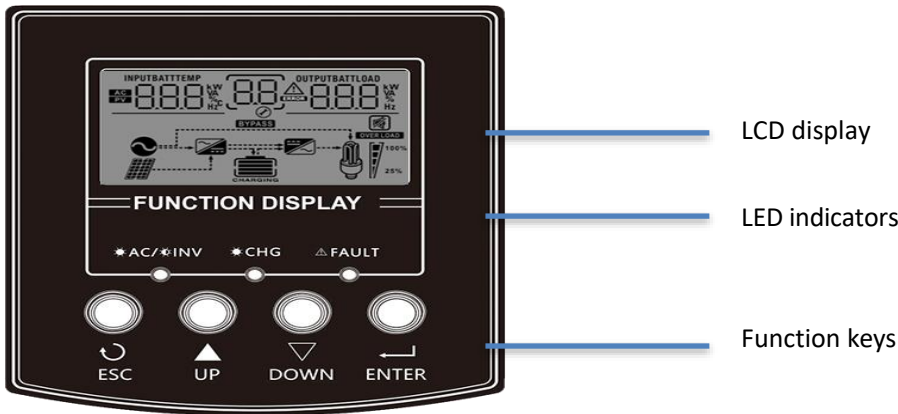
The control and display panel shown in the table below is on the front panel of the inverter. It contains three indicators, four function keys and an LCD display indicating operating status and input/output power information.



LED Indicator		Report	
	Green	Shining	The output is powered in Line mode.
		Flashing	The output is powered by battery or PV in battery mode.
	Green	Shining	The battery is fully charged
		Flashing	The battery is charging
<b>FAULT</b>	Red	Shining	There is a fault on the inverter
		Flashing	There was a warning on the inverter

## Function keys for 1KVA/2KVA with PWM and 3KVA/5KVA models

Function key	Description
ESC	To leave the current offer
UP	To go to the previous offer
DOWN	To move to the next offer
ENTER	To select or confirm a mode

## Icons on the LCD display

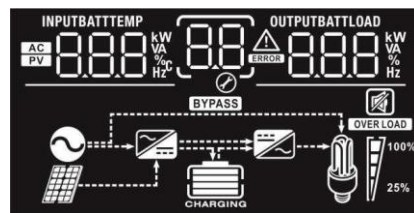







Icon	Function description
	Indicates AC input
	Indicates PV input
	Shows input voltage, input frequency, PV voltage, charging current (if PV is charging on 3K models), charger power (only on MPPT models), battery voltage.
	Shows the program settings
	Indicates warning and error codes. Warning: flashing with warning code..
	Fault: lighting with error code
	Indicates output voltage, output frequency, percentage of load, load in VA, load in watts, and discharge current.
	Indicates battery status of 0-24%, 25-49%, 50-74% and 75-100% in battery mode and charging status in connection mode.



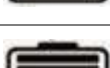

In AC mode, it displays the battery charging status.

Status	Battery voltage	LCD Display
Constant current mode / constant voltage mode	<2V/cell	The 4 stripes will flash sequentially.
	2 ~ 2.083V/cell	The bottom lane will be on and the other three lanes will flash in turn.
	2.083 ~ 2.167V/cell	The bottom two lanes will be lit and the other two lanes will flash alternately.
	> 2.167 V/cell	The lower three bars will be on and the upper bar will flash.
Floating mode. Floating mode. Batteries are fully charged.		All 4 lanes will be on

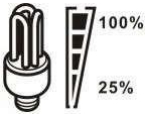

In battery mode, it will display the battery capacity.



Percentage of charge	Battery voltage	LCD Display
Charged >50%	< 1.85V/cell	
	1.85V/cell ~ 1.933V/Article	
	1.933V/cell ~ 2.017V/Article	
	> 2.017V/cell	
Charged < 50%	< 1.892V/cell	
	1.892V/cell ~ 1.975V/Article	
	1.975V/cell ~ 2.058V/Article	
	> 2.058V/cell	

**Load information**

	Indicates overload			
	It indicates load levels of 0-24%, 25-49%, 50-74% and 75-100%.			
	0%~24%	25%~49%	50%~74%	75%~100%
				

**Information about the mode of operation**

	Indicates that the unit is connected to the mains.
	Indicates that the unit is connected to the PV panel.
	It indicates that the load is supplied from the grid.

	Indicates that the charger circuit is working.
	Indicates that the DC/AC converter circuit is working.
<b>Mute option</b>	
	Indicates that the unit alarm is deactivated.

### LCD settings

After pressing and holding the ENTER button for 3 seconds, the unit enters setup mode. Press the "UP" or "DOWN" button to select the program settings. Then press the "ENTER" button to confirm the selection or the ESC button to exit.

### Program settings:

Programmes	Description	Choice of options	
00	Exit setup mode	Exit 00 ESC	
01	Output Source Priority: configure the priority of the load source	First solar 01 SOL	Solar power supplies energy to the load. If the solar energy is not sufficient to power all connected loads, the battery energy will simultaneously to power the load.  The mains power supply will only supply power to the appliances if any condition occurs: solar power is not available Battery voltage drops to the low level warning voltage or to the settings in program 12.
		Mains power (default) 01 UTI	Mains power will provide power to the loads. Solar and battery power will only provide power to the appliances when mains power is not available.



		<p>SBU</p>	<p>"Solar power supplies energy to appliances as the first priority. If solar power is not sufficient to power all connected loads, battery power will simultaneously supply power to the loads. The mains power supply only provides power to appliances when the battery voltage drops to either the low level warning voltage or the setting point in program 12. "</p>
--	--	------------	--

02	<p>Maximum charging current: Configure the total charging current for solar and mains chargers.</p> <p>(Max. Charging current = mains charging current + solar charging current)</p>	Options for 1KVA/2KVA model:	
		<p>10A</p>	<p>20A</p>
		<p>30A</p>	<p>40A (default for MPPT model)</p>
		<p>50A (default for PWM model)</p>	<p>60A (for MPPT model only)</p>

02	<p>Maximum charging current: Configure the total charging current for solar and mains chargers.</p> <p>(Max. Charging current = mains charging current + solar charging current)</p>	Options for 3KVA model:	
		<p>20A</p>	<p>30A</p>
		<p>40A (default for MPPT model)</p>	<p>50A (default for PWM model)</p>
		<p>60A</p>	<p>70A (PWM model only)</p>
		Options for 3KVA Plus/5KVA model:	
		<p>10A</p>	<p>20A</p>
		<p>30A</p>	<p>40A</p>





		50A (default for PWM model) 02 50 <sup>A</sup>	60A (default for MPPT model) 02 60 <sup>A</sup>
		70A 02 70 <sup>A</sup>	80A 02 80 <sup>A</sup>
		90A 02 90 <sup>A</sup>	100A 02 100 <sup>A</sup>
		110A 02 110 <sup>A</sup>	120A (for MPPT model only) 02 120 <sup>A</sup>
03	AC input voltage range	Instruments (default) 03 APL	If selected, the acceptable AC input voltage range will be between 90-280VAC.
		UPC 06 Lfd	If selected, the acceptable AC input voltage range will be between 170-280VAC
05	Batteries	AGM (default) 05 AGn	Lead 05 FLd
		Defined by the user 05 USE	If "User-Defined" is selected, the battery charging voltage and low DC limit voltage can be set in program 26, 27 and 29.
06	Automatic restart on overload	Restart disabled (Default)	Restart enabled 06 LfE
07	Automatic restart when overheating occurs	Restart disabled (default) 07 Lfd	Restart enabled 07 LfE
09	Output frequency	50Hz (default) 09 50 <sup>Hz</sup>	60Hz 09 60 <sup>Hz</sup>
		Available options for 1KVA/2KVA model:	
		10A 11 10A	20A (default) 11 20A









11	<p>Maximum charging current</p> <p>Note: If the setting value in program 02 is less than that in program v 11, the inverter will use the charging current from program 02 for the charger.</p>	Available options for 3KVA model:	
		15A 11 15A	25A (default) 11 25A
		Available options in 3KVA Plus/5KVA model:	
		2A 11 2A	10A 11 10A
		20A 11 20A	30A (default) 11 30A
		40A 11 40A	50A 11 50A
	60A 11 60A		
12	<p>Setting the voltage point back to the power source when selecting "SBU Priority" or "First Solar" in the 01 program.</p>	Available options for 1KVA model:	
		11.0V 12 BATT 11.0v	11.3V 12 BATT 11.3v
		11.5V (default) 12 BATT 11.5v	11.8V 12 BATT 11.8v
		12.0V 12 BATT 12.0v	12.3V 12 BATT 12.3v
		12.5V 12 BATT 12.5v	12.8V 12 BATT 12.8v





12	Setting the voltage point back to the power source when selecting "SBU Priority" or "First Solar" in the 01 program.	Available options for 2KVA/3KVA/3KVA Plus model:	
		22.0V 12 <sup>BATT</sup> 22.0 <sub>v</sub>	22.5V 12 <sup>BATT</sup> 22.5 <sub>v</sub>
		23.0V (default) 12 <sup>BATT</sup> 23.0 <sub>v</sub>	23.5V 12 <sup>BATT</sup> 23.5 <sub>v</sub>
		24.0V 12 <sup>BATT</sup> 24.0 <sub>v</sub>	24.5V 12 <sup>BATT</sup> 24.5 <sub>v</sub>
		25.0V 12 <sup>BATT</sup> 25.0 <sub>v</sub>	25.5V 12 <sup>BATT</sup> 25.5 <sub>v</sub>
		Available options for 5KVA model:	
		44V 12 <sup>BATT</sup> 44 <sub>v</sub>	45V 12 <sup>BATT</sup> 45 <sub>v</sub>
		46V (default) 12 <sup>BATT</sup> 46 <sub>v</sub>	47V 12 <sup>BATT</sup> 47 <sub>v</sub>
		48V 12 <sup>BATT</sup> 48 <sub>v</sub>	49V 12 <sup>BATT</sup> 49 <sub>v</sub>
		50V 12 <sup>BATT</sup> 50 <sub>v</sub>	51V 12 <sup>BATT</sup> 51 <sub>v</sub>
13	Setting the voltage point back to the battery when selecting "SBU Priority" or "The first solarium" in program 01.	Available options 1KVA model:	
		Battery fully charged 13 <sup>BATT</sup> FUL	12.0V 13 <sup>BATT</sup> 12.0 <sub>v</sub>
		12.3V 13 <sup>BATT</sup> 12.3 <sub>v</sub>	12.5V 13 <sup>BATT</sup> 12.5 <sub>v</sub>

	<p>12.8V</p>	<p>13.0V</p>
--	--------------	--------------



13	Setting the voltage point back to the battery when selecting "SBU Priority" or "First Solar" in the 01 program.	<p>13.3V</p>	<p>13.5V (default)</p>
		<p>13.8V</p>	<p>14.0V</p>
		<p>14.3V</p>	<p>14.5V</p>
		Available options for 2KVA/3KVA/3KVA Plus model:	
		<p>Battery fully charged</p>	<p>24V</p>
		<p>24.5V</p>	<p>25V</p>
		<p>25.5V</p>	<p>26V</p>
		<p>26.5V</p>	<p>27V (default)</p>
		<p>27.5V</p>	<p>28V</p>
		<p>28.5V</p>	<p>29V</p>

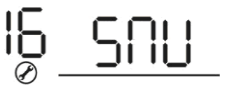



		Available options for 5KVA model:	
		Battery fully charged	48V
			
		49V	50V
			

13	Setting the voltage point back to the battery when selecting "SBU Priority" or "First Solar" in the 01 program.	51V	52V
			
		53V	54V (default)
			
		55V	56V
			
		57V	58V
			







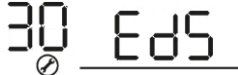

16	Charger source priority: charger source priority configuration	If this inverter/charger is operating in Line, Standby or Fault mode, the power supply can be programmed as shown below:	
		First Solar	First it will be solar energy that will charge the battery. Mains power will only charge the battery if solar power is not available energy.
			
		First mains power supply	Primarily the mains power will charge the battery. Solar energy will charge the battery only when mains power is not available.
			
		Solar and mains power (default)	The battery will be powered by solar energy and grid power at the same time.
			
		Jen Solar	Solar power will be the only source of charger regardless of whether any utility is available or not.
			

		When this inverter/charger is operating in battery mode or power saving mode, only solar power can charge the battery. Solar power will charge the battery if available and sufficient.	
18	Alarm control	Alarm on (default) 18 60N	Alarm off 18 60F
19	Automatic return to the default screen	Return to the default screen (default) 19 ESP	If selected, no matter how users switch the screen, it will automatically return to the default screen (input voltage / output voltage) after no button has been pressed for 1 minute.
		Remains on the last screen 19 FEP	If this option is selected, the screen will remain the most recent screen. The user will eventually switch.
20	Backlight control	Backlight on (default) 20 LON	Backlight off 20 LOF
22	Beeping when the primary source is interrupted	Alarm on (default) 22 AON	Alarm off 22 AOF
23	Overload Bypass: if enabled, the unit will switch to line mode if an overload occurs in battery mode.	Bypass disabled (default) 23 byd	Bypass enabled 23 byE
25	Error code logging	Recording enabled (default) 25 FEN	Recording disabled 25 FdS
26	Bulk phase voltage (C.V voltage)	1KVA default setting: 14.1V CU 26 14.1 <sup>BATT</sup> v	
		2KVA/3KVA/3KVA Plus default setting: 28.2V CU 26 28.2 <sup>BATT</sup> v	
		5KVA default setting: 56.4V CU 26 56.4 <sup>BATT</sup> v	

		<p>If a custom setting is selected in program 5, this program can be set. The setting range is from 12.5V to 15.0V for the 1K model, 25.0V to 30.0V for the 2KVA model, 25.0V to 31.5V for the 3KVA/3KVA Plus model and 48.0V to 61.0 V for the 5 KVA model. The increment of each click is 0.1 V.</p>
27	Voltage Phase Floating	<p>1KVA default setting: 13.5V</p> 
		<p>2KVA/3KVA/3KVA Plus default setting: 27.0V</p> 
		<p>5KVA default setting: 54.0V</p> 
		<p>If a custom setting is selected in program 5, this program can be set. The setting range is from 12.5V to 15.0V for the 1K model, 25.0V to 30.0V for the 2KVA model, 25.0V to 31.5V for the 3KVA/3KVA Plus model and 48.0V to 61.0V for the 5KVA model. The increment of each click is 0.1V.</p>

29	Voltage for disconnection at low DC	<p>1KVA default setting: 10.5V</p> 	
		<p>2KVA/3KVA/3KVA Plus default setting: 21.0V</p> 	
		<p>5KVA default setting: 42.0V</p> 	
		<p>If a custom setting is selected in program 5, this program can be set. The setting range is from 10.5V to 12.0V for the 1K model, 21.0V to 24.0V for the 2KVA/3KVA/3KVA Plus model and 42.0V to 48.0V for the 5KVA model.</p> <p>The increment of each click is 0.1 V. The low DC cutoff voltage will be fixed at the set value no matter what percentage of the load is connected.</p>	
30	Battery phase - equalization	<p>Equalization enabled</p> 	<p>Equalization disabled (default)</p> 
		<p>If "Flooded" or "User- Defined" is selected in program 05, this program can be set.</p>	



31	Voltage phase equalization	1KVA default setting: 14.6V 	
		2KVA/3KVA/3KVA Plus default setting: 29.2V 	
		5KVA default setting: 58.4V 	
		The setting range is from 12.5V to 15.0V for the 1KVA model, 25.0V to 30.0V for the 2KVA model, 25.0V to 31.5V for the 3KVA/3KVA Plus model and 48.0V to 61.0V for the 5KVA model. The increment of each click is 0.1V.	
33	Equalization phase time	60min (default) 	The setting range is from 5 minutes to 900 minutes. The increment of each click is 5 minutes.
34	Time limit of equalization phase	120min (default) 	The setting range is from 5 minutes to 900 minutes. The increment of each click is 5 min.
35	Interval phase equalization	30 days (default) 	The setting range is from 0 to 90 days. The increment of each click is 1 day
36	Immediate start of the equalization phase	Enabled 	Disabled (default) 
		<p>If the equalization function is enabled in program 30, this program can be set. If "Enabled" is selected in this program, this means that the battery equalization is immediately activated and the main</p> <p>The LCD page will display "E9". If "Disabled" is selected, it will cancel the equalization function until the next activated equalization time based on the program setting 35. At this time, the main page LCD does not display, "E9"</p>	

# Display settings



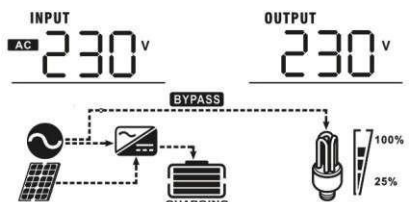
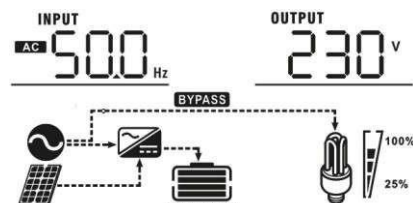
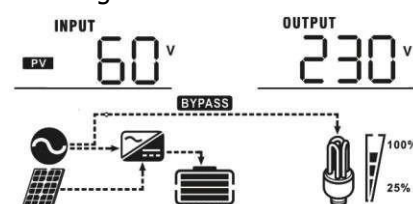
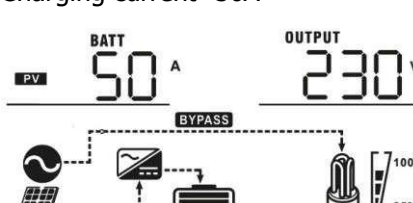
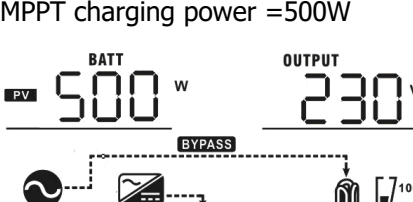
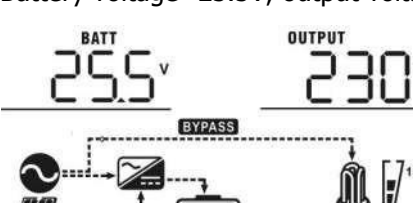

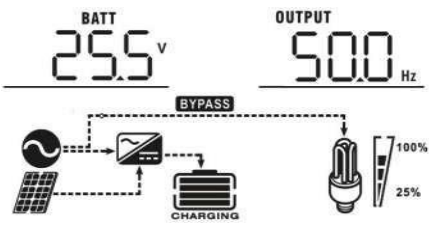
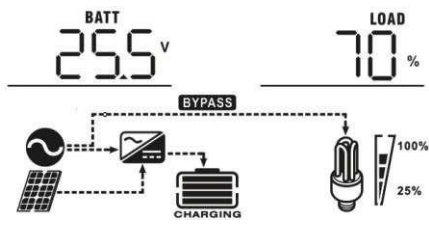
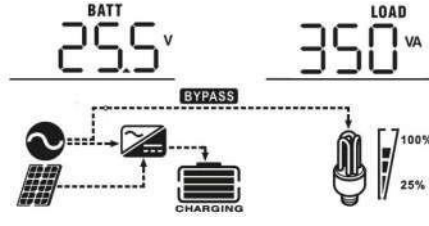
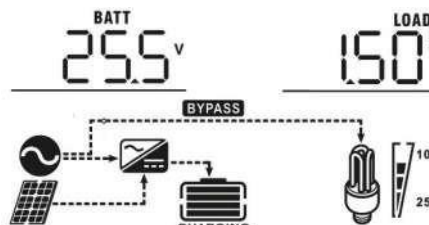

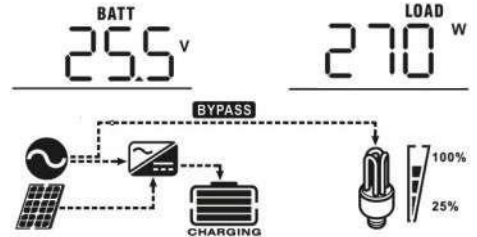
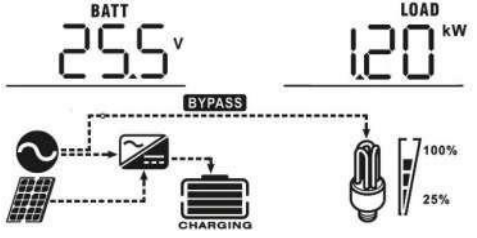
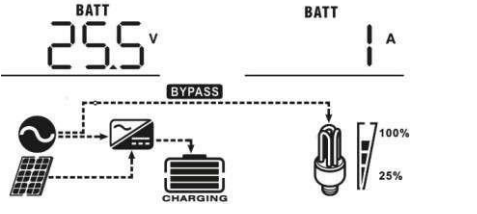
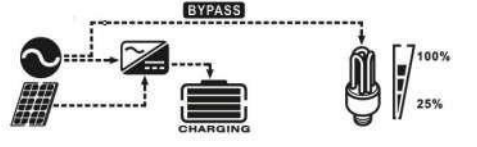
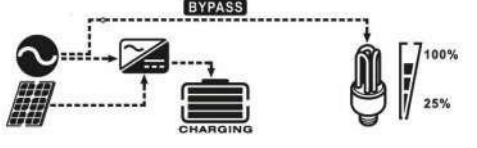

The information on the LCD display will alternately switch by pressing the "UP" or "DOWN" keys. The optional information will toggle in the following order: input voltage, input frequency, PV voltage, charging current, charging power (MPPT models only), battery voltage, output voltage, output frequency, load percentage, load in watts, load in VA, load in watts, DC discharge current, main CPU version and second CPU version.

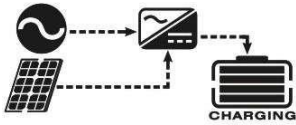
Selected information	LCD display
Input Voltage/Output Voltage (default screen)	Input voltage = 230V, output voltage = 230V 
Input frequency	Input frequency = 50Hz 
PV voltage	PV voltage = 60V 
Charging current	Charging current = 50A 
Charging power (MPPT models only)	MPPT charging power = 500W 
battery voltage, output voltage	Battery voltage = 25.5V, output voltage = 230V 

<p>Output frequency</p>	<p>Output frequency=50Hz</p> 
<p>Percentage of load</p>	<p>Load percentage =70%</p> 
<p>load in VA</p>	<p>If the connected load is less than 1 kVA, the load in VA will be represented by xxxVA as the graph below.</p>  <p>If the load is greater than 1 kVA (<math>\geq 1</math> KVA), the load in VA will represent x.xkVA as the graph below.</p> 

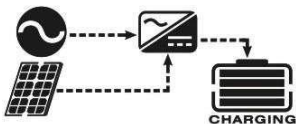
<p>Load in watts</p>	<p>When the load is less than 1 kW, the load in W will represent xxxW as the graph below.</p>  <p>If the load is greater than 1 kW (<math>\geq 1</math> kW), the load in W will represent x.xkW as in the graph below.</p> 
<p>Battery voltage / discharge current DC</p>	<p>Battery voltage=25.5V, current output=1A</p> 
<p>Main CPU - version</p>	<p>Main CPU - version 00014.04</p> 
<p>Second CPU - version</p>	<p>Second CPU - version 00003.03</p> 

## Description of operating mode

Operating mode	Description	LCD display
<p>Standby / power saving mode Note: * Standby mode: The inverter isn't on yet, but at the moment it can charge the battery without AC power output. *Save mode: If enabled, the inverter output will turn off when the load is connected load low or not detected.</p>	<p>The unit does not provide any output, but it can still to charge the batteries.</p>	<p>Charging with grid and photovoltaic energy.</p> 
		<p>Charging with mains power.</p> 
		<p>Charging by photovoltaic energy.</p> 
		<p>Not charging</p> 
<p>Failure mode "FAULT" Note: *Failure mode: errors are caused by a fault within the circuit or external causes such as overheating, output shorting, etc.</p>	<p>PV energy and grid power can charge batteries.</p>	<p>Charging with grid and photovoltaic energy.</p> 
		<p>Charging with mains power.</p> 
		<p>Charging by photovoltaic energy.</p> 
		<p>Not charging</p> 

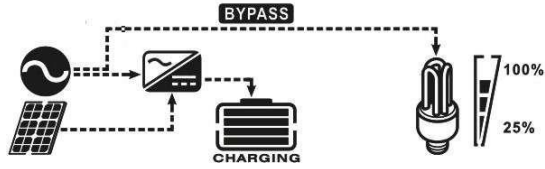
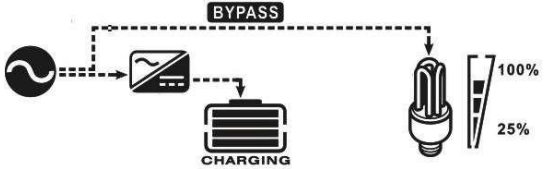
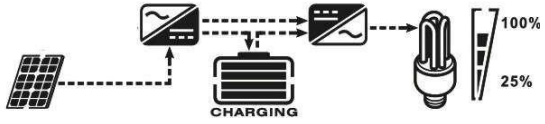
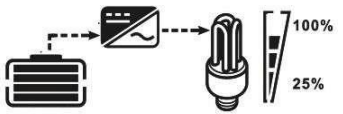
Operation mode	Description	LCD display
Line mode "Line"	The unit will provide output power from the network. It will also charge the battery in line mode.	Charging with grid and photovoltaic energy. 
		Charging with mains power. 
Battery mode	The unit will provide battery and PV power output.	Battery and solar panel energy 
		Battery power only 

# Description of the Equalization phase

The equalization phase reverses the effect of the accumulation of negative chemical effects such as stratification, a condition where the concentration of acid at the bottom of the battery is higher than at the top. Equalization also helps remove sulfate crystals that may have accumulated on the plates. Failure to allow this stage will reduce the overall capacity of the battery.

- **How to induce the Equalization phase**

First, you must enable the battery equalization function in the LCD 30 Setup Monitor program:

1. Setting the equalization interval in program 35.
2. Instantly active equalization in program 36.

- **When to start equalization?**

In the float phase, when the time for the equalization phase arrives or immediately, depending on the cycle set.

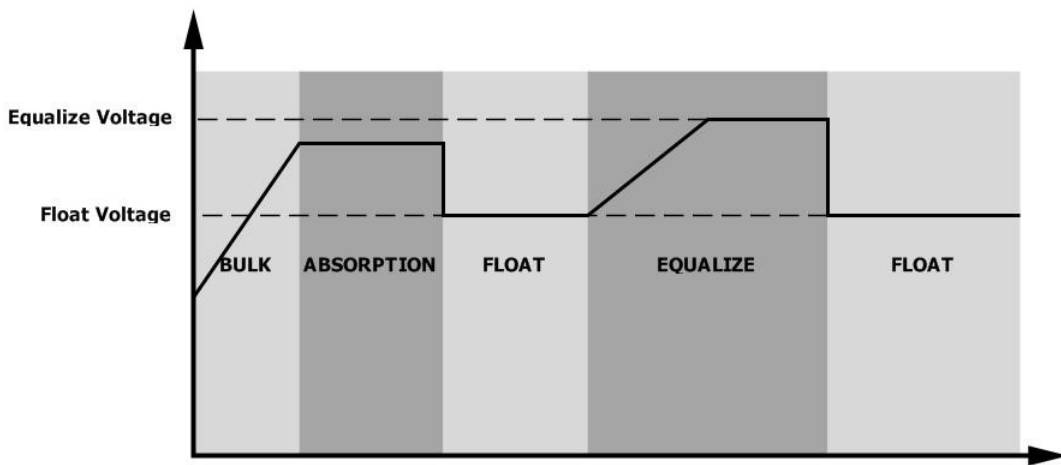

- **Phase equalization time and charging time limit**

In the equalization phase, the controller will supply energy to charge the battery as much as possible until the battery voltage rises to the battery equalization voltage. Then constant voltage regulation will be applied to keep the battery voltage at the battery equalization voltage. The battery will remain in the Equalization phase until the battery equalization time is adjusted.

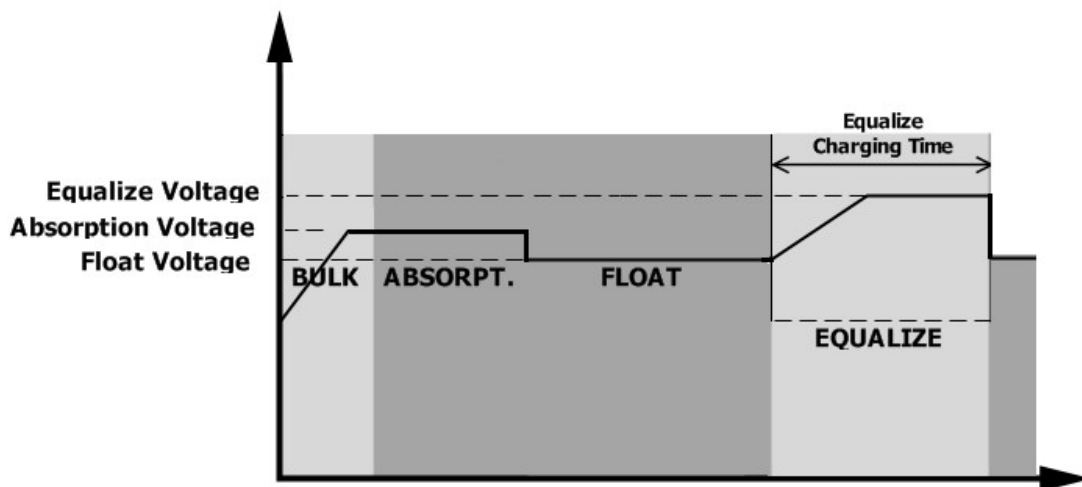





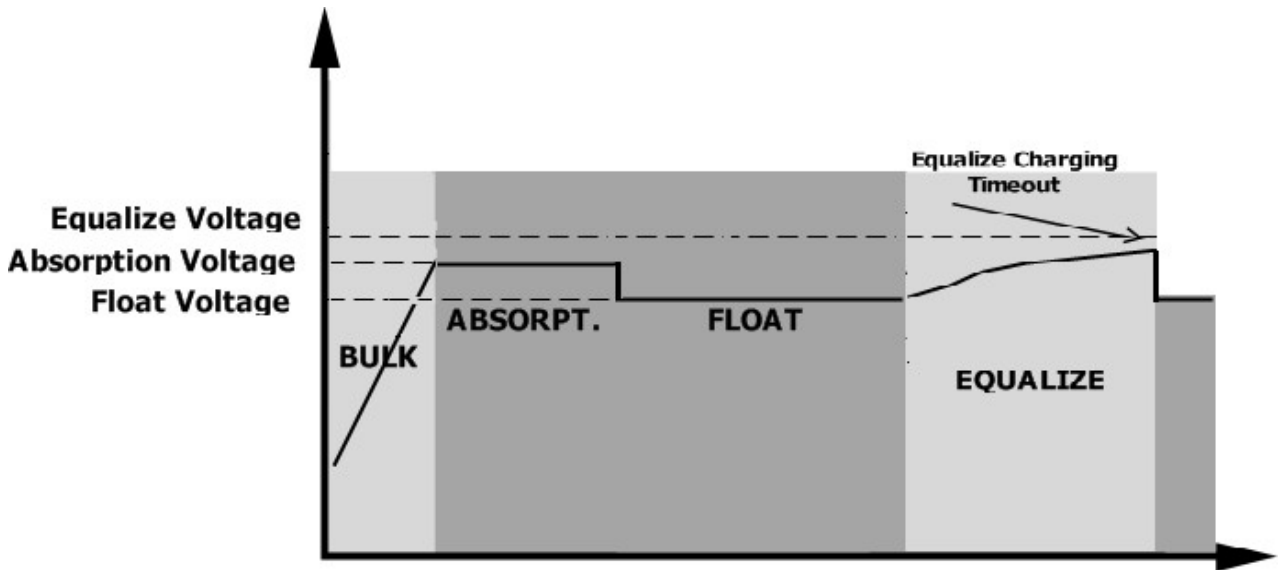











However, when the battery equalization time expires in the equalization phase and the battery voltage still does not rise to the voltage point to start the phase, the controller will extend the time of this phase until the battery voltage reaches the battery equalization voltage.

If the battery voltage is still lower than the set battery voltage, when the timeout is completed again, the controller stops the phase returns to the float phase.











## Error reference code

Error code	Error event	Icon
01	When the inverter is switched off, the fan is blocked.	
02	Overheating	
03	Battery voltage is too high	
04	Battery voltage is too low	
05	Short circuit or overheating of the output is detected	
06	The output voltage is abnormal. (For 3KVA model) Output voltage is too high. (For 3KVA Plus/ 5KVA model)	
07	Overload timeout has expired	
08	Bus voltage is too high	
09	Soft start bus failed	
51	Overcurrent or overvoltage	
52	Bus voltage is too low	
53	Inverter soft start failed	
55	DC overvoltage at AC output	
56	The battery connection is open	
57	Current sensor failed	
58	Output voltage is too low	

**Note: Error codes 51, 52, 53, 55, 56, 57 and 58 for 5KVA model.**

## Warning indication

Code warning	Event	Audible warning	Flashing icon
01	When the inverter is switched on, the fan is blocked.	Beeps every 3 seconds	

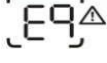
03	The battery is overcharged	Beep every second	
04	Weak battery	Beep every second	 
07	Overload	Beeps every 0.5 seconds	
10	Output power reduction	Beeps every 3 seconds	
E9	The equalization phase	Nothing	

# SPECIFICATIONS

CHANGER MODEL	1KVA	2KVA	3KVA	5KVA
<b>Input voltage waveform</b>	Sinusoidal (mains voltage or generator)			
<b>Rated input voltage</b>	230Vac			
<b>Low voltage for disconnection</b>	170Vac±7V (UPS); 90Vac±7V (instruments)			
<b>Recovery after low voltage</b>	180Vac±7V (UPS); 100Vac±7V (power supply)			
<b>High voltage for disconnection</b>	280Vac±7V			
<b>Recovery after high voltage</b>	270Vac±7V			
<b>Max AC input voltage</b>	300Vac			
<b>Rated input frequency</b>	50Hz/60Hz (Auto detection)			
<b>Low frequency for disconnection</b>	40±1Hz			
<b>Recovery after low frequency</b>	42±1Hz			
<b>High frequency for disconnection</b>	65±1Hz			
<b>Recovery after high frequency</b>	63±1Hz			
<b>Output short circuit protection</b>	Circuit breaker			
<b>Efficiency (Mode Line)</b>	>95% ( R rated load, battery fully charged )			
<b>Transfer time</b>	10ms (UPS); 20ms (Precision)			
<p><b>Reduction of output power:</b> When the AC input voltage drops to 170V, the output power will be reduced.</p>	<p>The graph illustrates the relationship between input voltage and output power. The vertical axis represents Output Power, and the horizontal axis represents Input voltage. Key points on the graph include:         <ul style="list-style-type: none"> <li>At 90V input, the output power is 50% of the rated power.</li> <li>As the input voltage increases from 90V to 170V, the output power increases linearly to the rated power level.</li> <li>For input voltages between 170V and 280V, the output power remains constant at the rated power level.</li> </ul> </p>			

Inverter model	1KVA	2KVA	3KVA	5KVA
<b>Rated output power</b>	1KVA/1KW	2KVA/2KW	3KVA/3KW	5KVA/5KW
<b>Output voltage waveform</b>	Net sine wave			
<b>Output Voltage Regulation</b>	230Vac±5%			
<b>Output Frequency</b>	50Hz			
<b>Peak efficiency</b>	93%			
<b>Overload protection</b>	5s@≥150% load; 10s@105%~150% load			
<b>Surge capacity</b>	2* rated power for 5 seconds			
<b>Rated DC input voltage</b>	12Vdc	24Vdc	24Vdc	48Vdc
<b>Cold start voltage</b>	11.5Vdc	23.0Vdc	23.0Vdc	46.0Vdc
<b>Low DC voltage warning</b>				
@ load < 50%	11.5Vdc	23.0Vdc	23.0Vdc	46.0Vdc
@ load ≥ 50%	11.0Vdc	22.0Vdc	22.0Vdc	44.0Vdc
<b>Return to normal after low voltage</b>				
@ load < 50%	11.7Vdc	23.5Vdc	23.5Vdc	47.0Vdc
@ load ≥ 50%	11.5Vdc	23.0Vdc	23.0Vdc	46.0Vdc
<b>Low voltage disconnection</b>				
@ load < 50%	10.7Vdc	21.5Vdc	21.5Vdc	43.0Vdc
@ load ≥ 50%	10.5Vdc	21.0Vdc	21.0Vdc	42.0Vdc
<b>Recovery after disconnection High voltage</b>	15Vdc	30Vdc	32Vdc	62Vdc
<b>disconnection No-load power consumption</b>	16Vdc	31Vdc	33Vdc	63Vdc
			<25W	<55W

Mains charging mode					
CHARGER MODEL	1KVA	2KVA	3KVA	3KVA Plus	5KVA
<b>Charging algorithm</b>	3-step				
<b>Max AC charging current</b>	20Amp(@V <sub>I/P</sub> ρ=230Vac)		25Amp (@V <sub>I/P</sub> ρ=230Vac)	60Amp (@V <sub>I/P</sub> =230Vac)	
<b>Voltage Phase Bulk</b>	Lead-acid battery		14.6	29.2	58.4

	<b>AGM / Gel batteries</b>	14.1	28.2	Forward
--	----------------------------	------	------	---------

<b>Voltage Phase Float</b>	13.5Vdc	27Vdc	54Vdc
----------------------------	---------	-------	-------

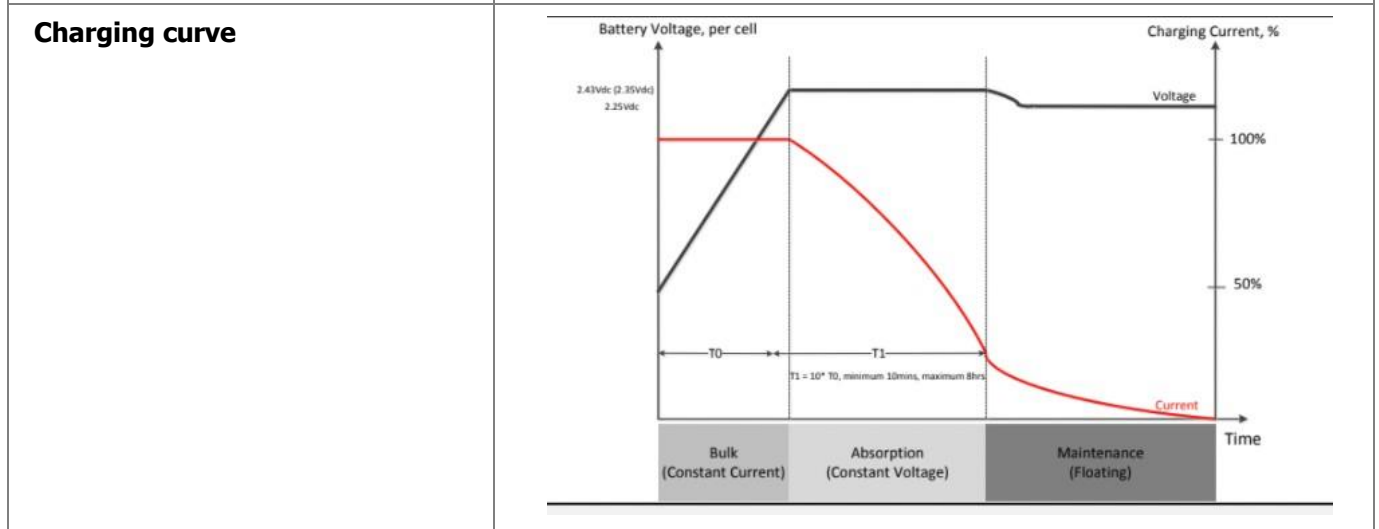

**PWM solar charging mode**

CHARGER MODEL	1KVA	2KVA	3KVA	5KVA
<b>Charging current</b>	50Amp			
<b>System voltage</b>	12Vdc	24Vdc	48Vdc	
<b>Operating voltage range</b>	15~18Vdc	30~32Vdc	60~72vdc	
<b>Max. Open circuit voltage of PV array</b>	55Vdc	80Vdc	105Vdc	
<b>DC Voltage Accuracy</b>	+/-0.3%			
<b>Maximum charging current (AC charger plus solar charger)</b>	50Amp	70Amp	110Amp	

**MPPT solar charging mode**

CHARGER MODEL	1KVA	2KV A	3KVA	3KVA Plus	5KVA
<b>Charging current</b>	40Amp		80Amp		
<b>MPPT PV array voltage range</b>	15~80Vdc	30~80Vdc	30~115Vdc	60~115Vdc	
<b>Max. Open circuit voltage of PV array</b>	102Vdc		145Vdc		
<b>Maximum charging current (AC charger plus solar charger)</b>	60Amp		140Amp		

a

<b>CHANGER MODEL</b>	<b>1KVA</b>	<b>2KV A</b>	<b>3KVA</b>	<b>3KVA Plus</b>	<b>5KVA</b>
<b>Security certificate</b>	CE				
<b>Working temperature</b>	-10°C to 50°C				
<b>Storage temperature</b>	- 15°C~6 0°C				
<b>Wooliness</b>	5% to 95% relative humidity, non-condensing				
<b>Dimensions</b>	88 x 225 x 320		100 x 285 334	100 x 300 x 440	
<b>Net weight, kg (PWM model)</b>	4.4±5 %	5±5 %	6.5±5%	N/A±5%	8.8±5%
<b>Net weight, kg (MPPT model)</b>	4.4±5 %	5±5 %	6.8±5%	8.9±5%	10±5%

Installation dimensions

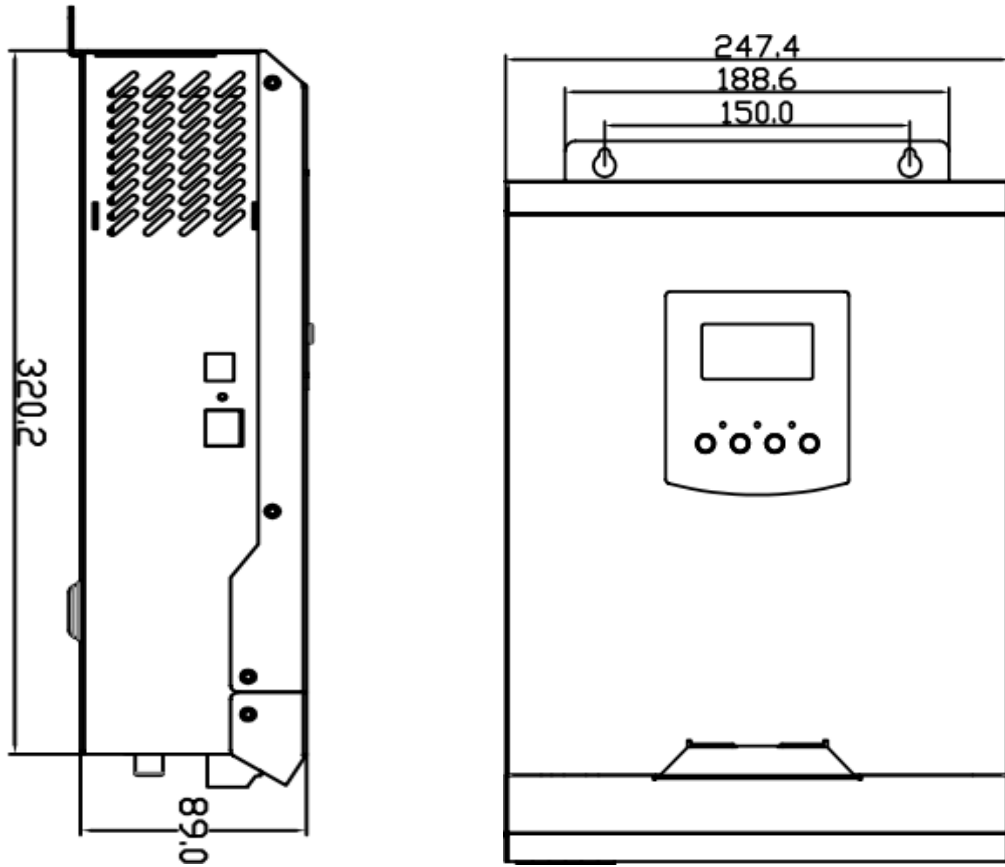

1KVA /2KVA PWM Installation description and dimensions for installation

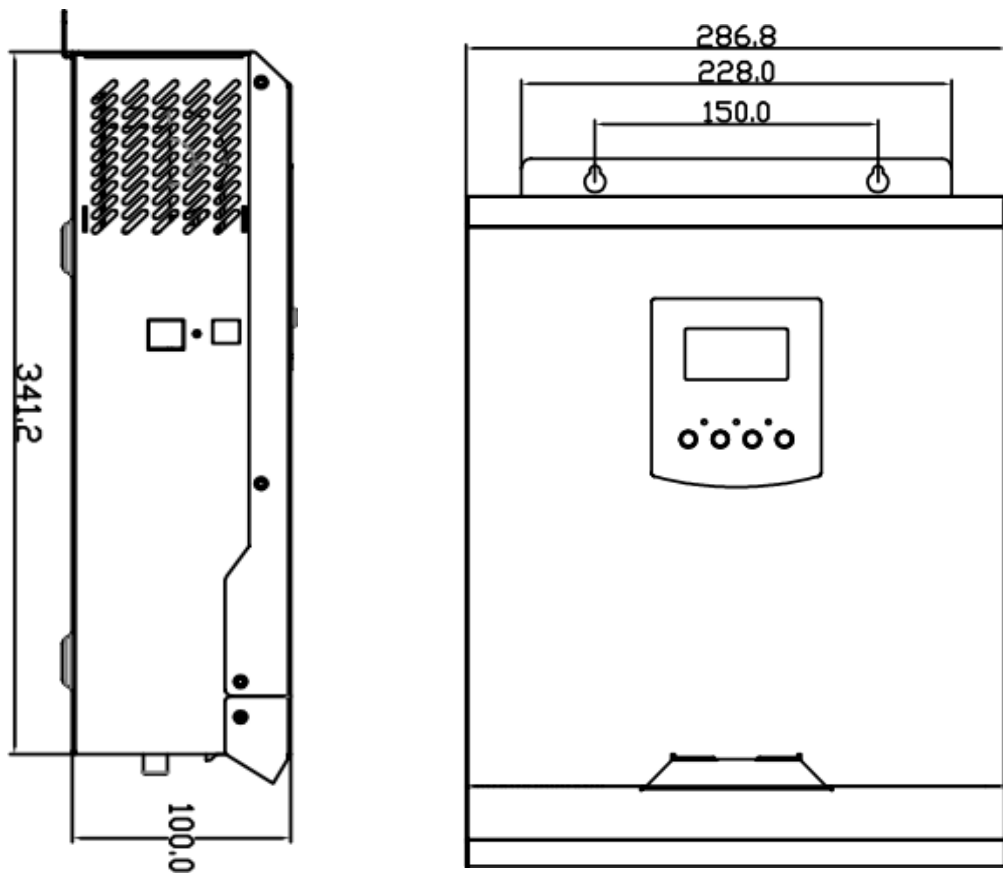

## 3KVA PWM Installation description and dimensions for installation



# Troubleshooting

The Problem	LCD/LED/Buzzer	Cause	Solution
The unit will automatically shut down during startup.	The LCD/LED and buzzer will be active for 3 seconds and then turn off.	Battery voltage is too low (<1.91 V/cell)	<ol style="list-style-type: none"> <li>1. Recharge the battery.</li> <li>2. Replace the battery.</li> </ol>
No response after switching on.	No indication	<ol style="list-style-type: none"> <li>1. Battery voltage is too low (&lt;1.4 V/cell)</li> <li>2. The internal fuse is off.</li> </ol>	<ol style="list-style-type: none"> <li>1. To replace the fuse, contact a service centre.</li> <li>2. Recharge the battery.</li> <li>3. Replace the battery.</li> </ol>
Power is available, but the unit is operating in battery mode.	The input voltage is displayed as 0 on the LCD and the green LED flashes.	Input protection is activated	Check that the AC circuit breaker is not tripped and that the AC line is properly connected.
	Green LED flashing	Insufficient AC input quality	<ol style="list-style-type: none"> <li>1. Check that the AC wires are not too thin or too long.</li> </ol> Check that the generator (if used) is working well or that the input voltage range setting is correct.
	Green LED flashing	Set "First Solar" as the priority of the output source.	First, change the priority of the output source to the network.
When the unit is switched on, the internal relay is repeatedly switched on and off.	LCD display and LEDs flash	The battery is disconnected	Check that the battery is correctly connected
The buzzer beeps continuously and the red LED lights up.	Error code 07	Overload error. The inverter is 105% overloaded and the time has expired.	Reduce the connected load by turning off some devices.
	Error code 05	Output shorted.	Check that the wiring is well connected and remove abnormal loads.
		The temperature of the internal inverter components is over 120°C. (Only available for 1-3KVA models)	Check that the air flow through the unit is not blocked or the ambient temperature is not too high.
	Error code 02	The internal temperature of the inverter component is over 100°C.	
	Error code 03	The battery's overcharged.	Check that the specification and quantity of batteries meet the requirements.
		The battery voltage is too high.	Check that the specification and quantity of batteries meet the requirements.
Error code 01	Fan error	Replacing the fan	

Error code 06/58	Abnormal output (inverter voltage is less than 190 Vac or greater than 260 Vac.)	1. Reduce the load. 2. Send the equipment for repair
Error code 08/09/53/57	Internal components have failed.	Send the equipment for repair
Error code 51	Overcurrent or overvoltage.	Reboot the unit, if the error recurs, send the unit in for repair
Error code 52	Bus voltage is too low.	
Error code 55	The output voltage is unbalanced.	
Error code 56	The battery is not properly connected or the fuse is blown.	If the battery is well connected, send the device in for repair